

Bloque de contrapeso
 Counterweight blocks
 Gegengewichtsblöcke
 Bloc de contrepoid
 Blocco di contrappeso

	52 m			50 m			46,5 m			41 m		
	A	B	C	A	B	C	A	B	C	A	B	C
	5	-	-	5	-	-	5	-	-	4	-	1
	11500 Kg			11500 Kg			11500 Kg			10050 Kg		

	35 m			30 m			23,6 m		
	A	B	C	A	B	C	A	B	C
	3	1	-	3	-	-	2	-	-
	8300 Kg			6900 Kg			4600 Kg		

Curvas de cargas, Load diagrams, Lastkurven, Courbes de charges, Curve di carico

52 m 	18	20	23,6	24	25,1	26	28	30	33	35	37	39	41	44	46,5	48	50	52	m		
	2500	2500	2500	2500	2500	2400	2215	2055	1850	1730	1625	1535	1450	1335	1270	1210	1150	1100	Kg		
	9	12	15	15,5	18	21	23,6	27	30	33	35	38	41	44	46,5	48	50	52	m		
	4000	4000	4000	4000	3400	2870	2590	2160	1900	1700	1580	1430	1300	1190	1120	1060	1000	950	Kg		
50 m 	18	20	23,6	24	26	27,8	28	30	33	35	37	39	41	44	46,5	48	50	m			
	2500	2500	2500	2500	2500	2500	2480	2300	2075	1945	1825	1725	1630	1505	1430	1365	1300	Kg			
	9	12	15	17,2	18	21	23,6	27	30	33	35	38	41	44	46,5	48	50	m			
	4000	4000	4000	4000	3815	3220	2900	2430	2150	1925	1795	1625	1480	1355	1280	1215	1150	Kg			
46,5 m 	18	20	23,6	24	26	28	30	31,1	33	35	37	39	41	44	46,5	m					
	2500	2500	2500	2500	2500	2500	2500	2335	2190	2065	1945	1840	1705	1620	Kg						
	9	12	15	18	19,2	21	23,6	27	30	33	35	38	41	44	46,5	m					
	4000	4000	4000	4000	4000	3635	3290	2750	2440	2190	2040	1850	1690	1555	1470	Kg					
41 m 	18	20	23,6	24	26	28	30	31,5	33	35	37	39	41	m							
	2500	2500	2500	2500	2500	2500	2500	2380	2230	2100	1980	1875	Kg								
	9	12	15	18	19,5	21	23,6	27	30	33	35	38	41	m							
	4000	4000	4000	4000	4000	3700	3350	2800	2490	2230	2080	1890	1725	Kg							
35 m 	18	20	23,6	24	26	28	30	32,4	33	35	m										
	2500	2500	2500	2500	2500	2500	2500	2450	2300	Kg											
	9	12	15	18	20,1	21	23,6	27	30	33	35		m								
	4000	4000	4000	4000	4000	3815	3450	2890	2570	2300	2150		Kg								
30 m 	18	20	23,6	24	26	28	30	m													
	2500	2500	2500	2500	2500	2500	2500	Kg													
	9	12	15	18	19,6	21	23,6	27		30	m										
	4000	4000	4000	4000	4000	3720	3360	2815		2500	Kg										
23,6 m 	18	20	23,6	m																	
	2500	2500	2500	Kg																	
	9	12	15	18		18,1	21	23,6	m												
	4000	4000	4000	4000		3415	3000	Kg													

Mecanismos, Mechanisms, Antriebe, Mécanismes, Meccanismi

* 25 Hp (18,5 Kw) 3V									
H.B.G. 84 S/R Ø10mm									
	240 m	m/min	8	31	62	4	16	31	
		Kg	2500	2500	1500	4000	4000	2600	
		Kw	18,5	18,5	18,5	18,5	18,5	18,5	
		m/min	30 / 60			30 / 60			
		Kw	1,5 / 3			1,5 / 3			
		r.p.m	0,3	0,6	0,9	0,3	0,6	0,9	
		Kw	2 x 5,5			2 x 5,5			
		m/min	20			20			
		Kw	2 x 2,2			2 x 2,2			

* 25 Hp (18,5 Kw) INV									
H.B.G. 94 S/R Ø10mm									
	265 m	m/min	8	31	62	4	16	31	
		Kg	2500	2500	1500	4000	4000	2600	
		Kw	18,5	18,5	18,5	18,5	18,5	18,5	

- * Opcional / Optional / Opzionale /
- ⬆️ Elevación / Hoisting / Heben / Levage / Sollevamento
- ◼️ Distribución / Trolleying / Katzfahren / Distribution / Distributions
- ⦿ Orientación / Slewing / Schwenken / Orientation / Rotazione
- ⚙️ Traslación / Travelling / Schienenfahren / Translation / Traslazione

15 Hp (11Kw) 3V									
H.B.G. 84 S/R Ø10mm									
	240 m	m/min	8	29	58	4	15	30	
		Kg	2500	2500	1000	4000	4000	2500	
		Kw	11,5	11,5	11,5	11,5	11,5	11,5	

	25 m	50 m	100 m
15 Hp (11,5 KW) 3V	4 x 16 mm ²	4 x 16 mm ²	4 x 25 mm ²
25 Hp (18,5 KW) 3V	4 x 25 mm ²	4 x 25 mm ²	4 x 25 mm ²
25 Hp (18,5 KW) INV	4 x 25 mm ²	4 x 25 mm ²	4 x 25 mm ²

 CEI 38 IEC 38	400 V 50 Hz	* 380 V 60 Hz	* 25 Hp (18,5 Kw) 31 KW / 120 kVA
			15 Hp (11,5 Kw) 3V 24KW / 90 kVA

Windzone A-B / DIN 15019

Mástil / Reacciones

Masts / Reactions

Maste / Eckdrücke

Mat / Réactions

Torre / Reazioni

- D: TORRE S/TL 50-52 1.20 M39/M39 8/8
- E: TORRE TL 55 1.20 M39/M39 8/8
- J: CAMPANA S17 10m 1.2/1.7 M39/M45 8/8
- K: TORRE S17 1.70 M45 8/8
- L: TORRE S17 1.70 M45 16/8
- M: TORRE S17 1.70 M45 16/16
- N: CAMPANA S21-S17 8/8 M45
- O: TORRE S21 8/8 M45
- P: TORRE S21 16/8 M45
- X: CAMPANA C2322/21 16 /16 M45L /M45
- T: TORRE S2322 16 /16 M45L
- U: TORRE S2326 16 /16 M52 /M45L
- Z: TORRE S2326 24 /16 M52

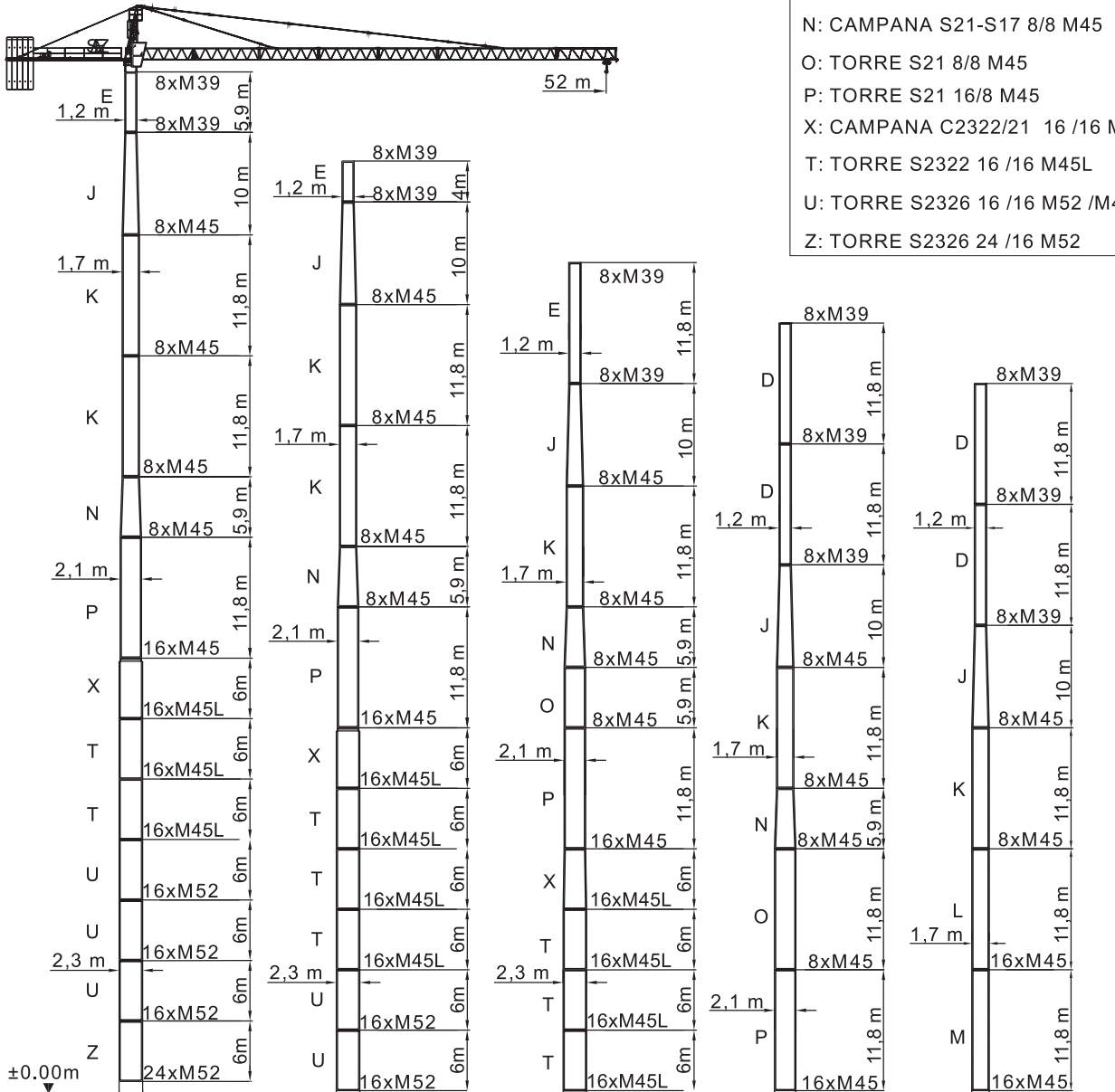

S75R24/26	S75R16/26	S75R16/22	S70R/16	S60R/16
H: 100,7m	H: 91,6 m	H: 81,5 m	H: 75,2 m	H: 69,3 m
P(t): 77.472	P(t): 76.351	P(t): 147	P(t): 58,6	P(t): 45
T(t): 27.523	T(t): 24.465	T(t): 20	T(t): 15,85	T(t): 11,9
M(t-m): 1906,22	M(t-m): 1486,24	M(t-m): 1144,3	M(t-m): 723,7	M(t-m): 510

Windzone A-B / DIN 15019
 Mástil / Reacciones
 Masts / Reactions
 Maste / Eckdrücke
 Mat / Réactions
 Torre / Reazioni

D: TORRE S/TL 50-52 1.20 M39/M39 8/8
 E: TORRE TL 55 1.20 M39/M39 8/8
 J: CAMPANA S17 10m 1.2/1.7 M39/M45 8/8
 K: TORRE S17 1.70 M45 8/8
 L: TORRE S17 1.70 M45 16/8
 M: TORRE S17 1.70 M45 16/16

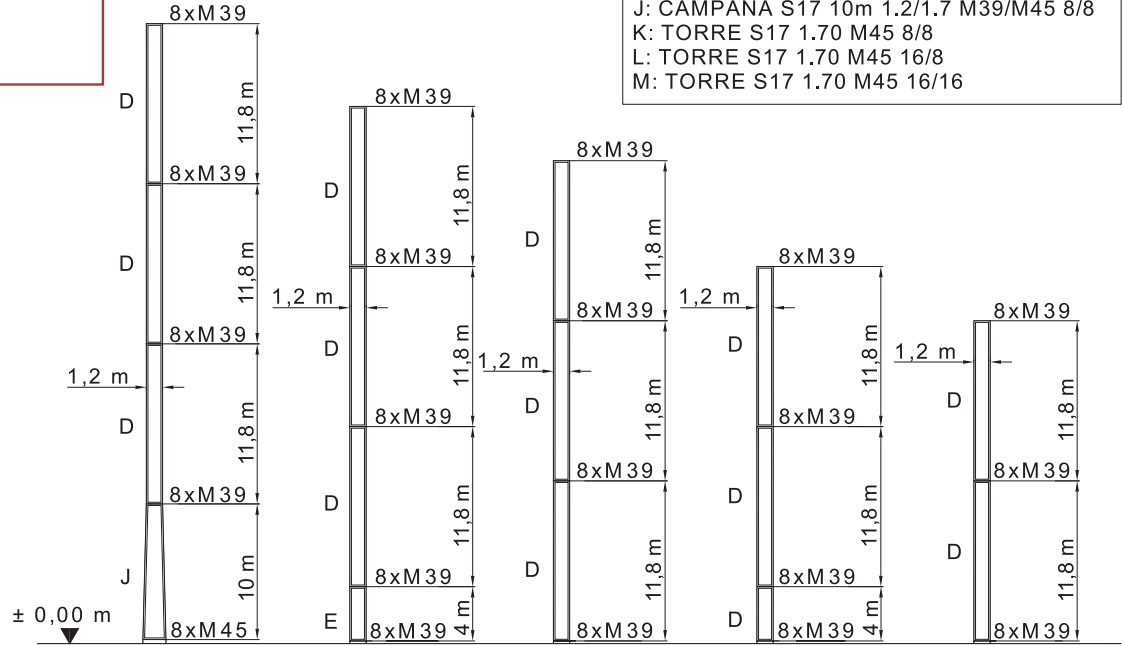

S60/8	S52R	S51	S51	S51
H: 45,7 m	H: 39,65 m	H: 35,65 m	H: 27,85 m	H: 23,85 m
M(t.m): 200,7	M(t.m): 150,9	M(t.m): 95,1	M(t.m): 80,9	M(t.m): 74,9
T(t): 6,4	T(t): 6,1	T(t): 5,9	T(t): 5,4	T(t): 4,9
P(t): 28,5	P(t): 26,8	P(t): 26,5	P(t): 24,8	P(t): 24,1

D: TORRE S/TL 50-52 1.20 M39/M39 8/8
 E: TORRE TL 55 1.20 M39/M39 8/8
 J: CAMPANA S17 10m 1.2/1.7 M39/M45 8/8
 K: TORRE S17 1.70 M45 8/8
 L: TORRE S17 1.70 M45 16/8
 M: TORRE S17 1.70 M45 16/16

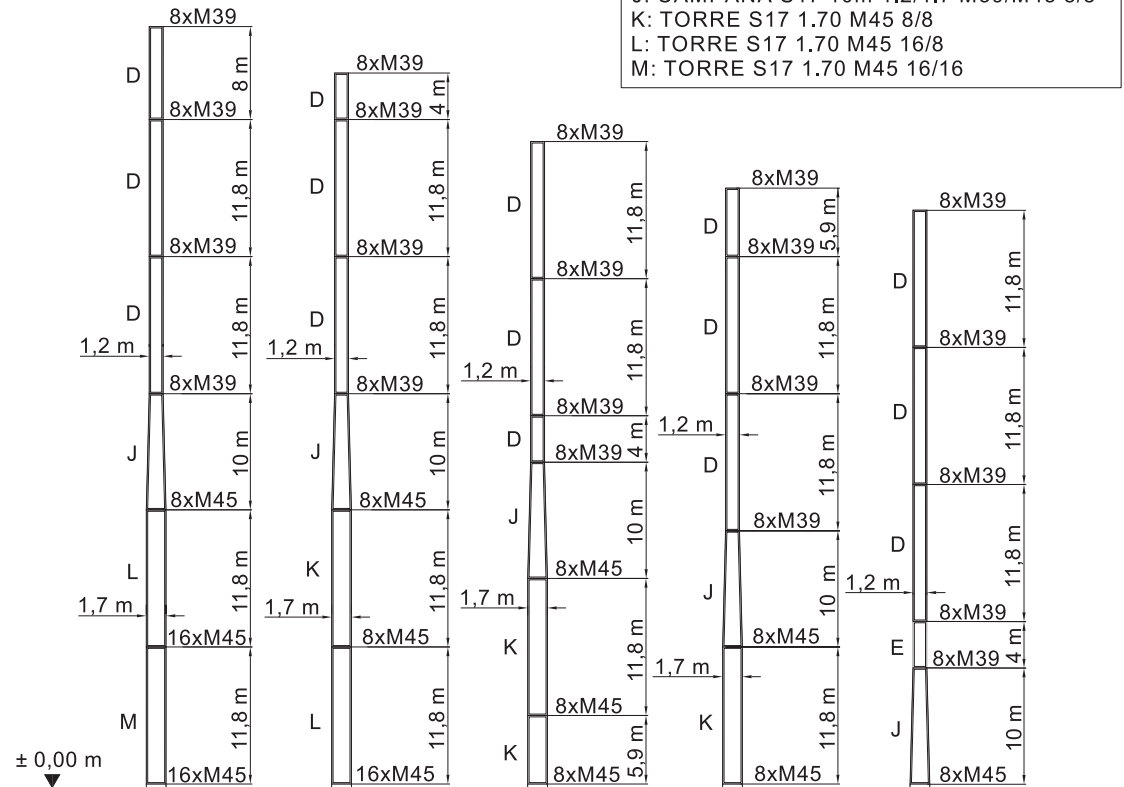

S60R/16	S60R/16	S60/8	S60/8	S60/8
H: 65,5 m	H: 61,5 m	H: 55,6 m	H: 51,6 m	H: 49,7 m
P(t): 42,6	P(t): 42	P(t): 39	P(t): 36	P(t): 34
T(t): 11,5	T(t): 10,6	T(t): 7,7	T(t): 7,3	T(t): 7,04
M(t.m): 420	M(t.m): 331	M(t.m): 269	M(t.m): 250,6	M(t.m): 239,3

Windzone A-B / DIN 15019
 Bloque lastre de base
Base ballast block
 Grundballastblöcke
Bloc de lest de base
 Blocco di zavorra alla base

D : TORRE S/TL 50-52 1.20 M 39/M 39 8/8
 E : TORRE TL 55 1.20 M 39/M 39 8/8
 J : CAMPANA S17 10m 1.20/1.70 M 39/M 45 8/8

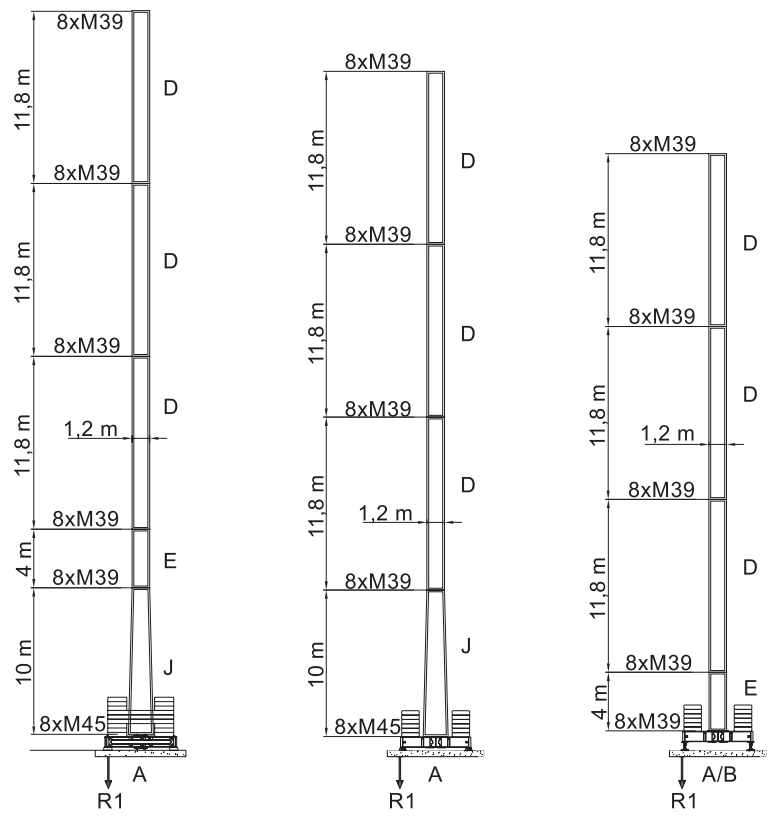

H(m): 50,6	H(m): 46,5	H(m): 40,7
4,5 x 4,5 m - 1,7 - HM 700	4,5 x 4,5 m - 1,2 / 1,7 - HB 700	3,8 x 3,8 m 1,2 HB 600
LASTRE: 121,6 Tn	LASTRE: 98,8 Tn	LASTRE: 72,6 Tn
R1= 95,6 Tn	R1= 79,2 Tn	R1= 66,15 Tn

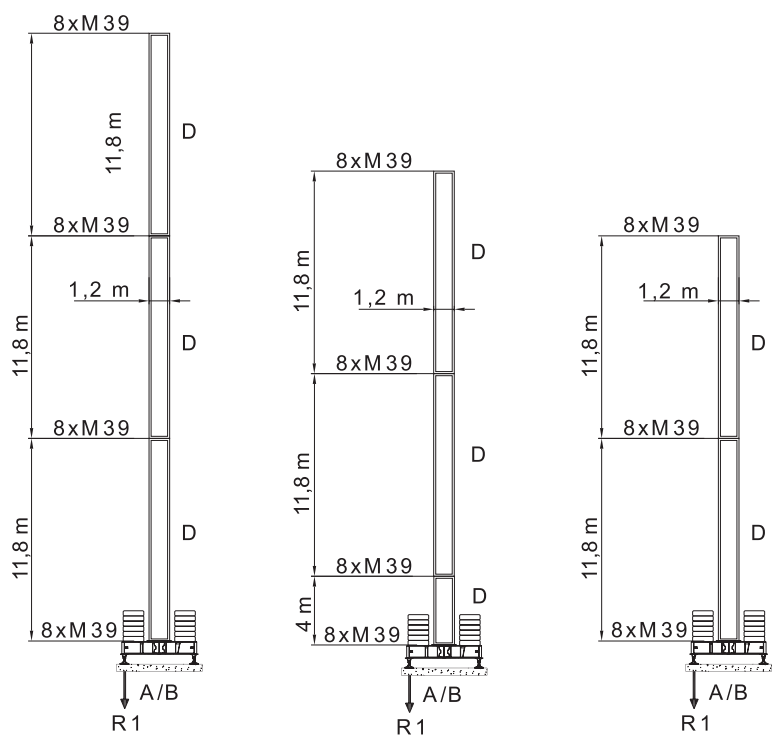

H(m): 36,4	H(m): 28,6	H(m): 24,6
3,8 x 3,8 1,2 HB 600	3,8 x 3,8 1,2 HB 600	3,8 x 3,8 M 1,2 HB 600
LASTRE: 53 Tn	LASTRE: 53 Tn	LASTRE: 45,6 Tn
R1= 46,96 Tn	R1= 43,12 Tn	R1= 39,2 Tn

L(m) W(m) H(m) Peso(Kg)

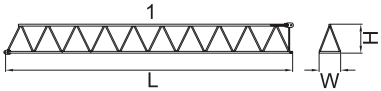
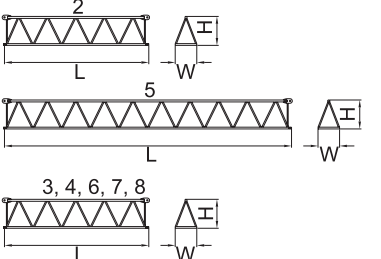
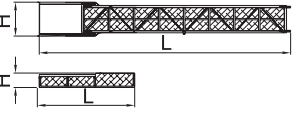
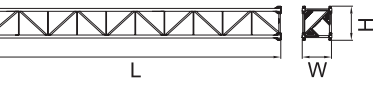
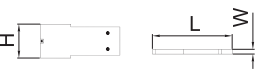
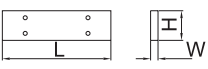
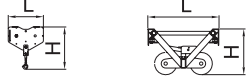
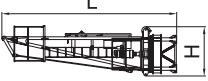
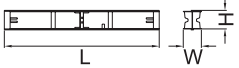
<p>Pluma tramo primero / Jib heel section Ausleger-Anlenkstück / Pied de flèche Settore articolato di braccio</p>		<p>1 11,85 1,04 1,32 982</p>
<p>Elemento intermedio de pluma Intermediate jib section / Ausleger-Zwischenstück Élément interm. de flèche / Spezzone di braccio</p>		<p>2 5,94 0,95 1,32 465 3 5,94 0,95 1,22 475 4 5,94 0,95 1,22 450 5 11,74 0,95 1,32 915 6 5,14 0,95 1,22 328 7 3,64 0,95 1,22 225 8 2,0 0,95 1,22 142</p>
<p>Contrapluma / Counter-jib Gegenausleger / Contre-flèche Controbraccio</p>		<p>11,5 0,26 1,48 1480 4,05 0,33 0,58 96</p>
<p>Elemento de torre / Tower section Turmstück / Élément de mât Elemento di torre</p>		<p>D 11,8 1,2 1,38 3017 D 8,0 1,2 1,38 2075 D 5,9 1,2 1,38 1560 D 4,0 1,2 1,38 1100 E 11,8 1,2 1,38 3782 E 8,0 1,2 1,38 2654 E 5,9 1,2 1,38 2090 E 4,0 1,2 1,38 1527 J 10 1,85 1,38 3520 K 11,8 1,85 1,85 4600 K 5,9 1,85 1,85 2472 K 3 1,85 1,85 1425 L 11,8 1,85 1,85 5520 M 11,8 1,85 1,85 5670 N 5,9 2,27 2,27 3500 O 11,8 2,27 2,27 5044 O 5,9 2,27 2,27 2640 O 3 2,27 2,27 1545 P 11,8 2,27 2,27 5700 X 6 2,27 2,29 4000 T 6 2,27 2,29 4300 U 6 2,31 2,34 5910 Z 6 2,61 2,34 5980</p>
<p>Bloque de contrapeso / Counterweight blocks Gegengewichtsblöcke / Bloc de contrepoids Blocco di contrappeso</p>		<p>A 2,94 0,30 1,25 2300 B 2,94 0,18 1,25 1400 C 1,70 0,18 1,25 850</p>
<p>Bloque lastre de base / Base ballast block Grundballastblöcke / Bloc de lest de base Blocco di zavorra alla base</p>		<p>4,4 1,2 0,3 3800</p>
<p>Gancho y Carro / Hook and Trolley/Lasthaken - Laufkatze/ Crochet - Chariot/Gancio e Carrello</p>		<p>0,75 0,12 1,40 164 0,96 1,10 0,62 118</p>
<p>Cabeza de torre / Tower head/Turmspitze / Porte - flèche/Testa di torre</p>		<p>6,5 1,8 1,7 3504</p>
<p>Viga principal base / Main base beam/ Hauptträger für fundamentkreuz Poutre de châssis de base/ Trave principale della base</p>		<p>5,72 0,67 0,65 1560</p>

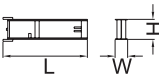
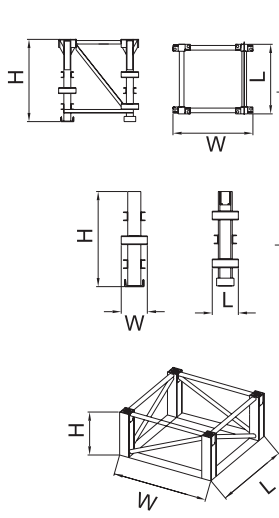
		L(m)	W(m)	H(m)	Peso(Kg)
Semiviga secundaria base / Half base beam / Halbträger für fundamentkreuz semipoutre de châssis de base/ Semitrave secundaria della base		2,77	0,45	0,665	800
Elemento de empotre / Foundation anchor / Fundamentanker / Élément de scellement / El annegare.					
	S51	1,2	1,38	1,42	496
	S52R	1,2	1,38	1,42	594
	S60/8	1,85	1,85	1,6	956
	S60R/16	1,85	1,85	1,6	1108
	S70/8	2,28	2,28	1,6	1122
	S70R/16	2,28	2,28	1,6	1274
	S75R16/22 (4x)	0,5	0,5	2,5	710
	S75R16/26 (4x)	0,5	0,5	2,5	790
	S75R24/26 (4x)	0,5	0,5	2,5	850
	DIMA	2,31	2,34	0,8	1650

ESPECIFICACIONES SUJETAS A MODIFICACIONES SIN PREVIO AVISO.

Specifications subject to modification without notice.
 Obiges kann ohne berstaendigung geaendert werden.
 Specifications susceptibles de modification sans avis préalable.
 Specifiche suscettibili di variazioni senza preavviso.

DECLINAMOS TODA RESPONSABILIDAD DERIVADA DE LA INFORMACION PROPORCIONADA.

This information is supplied without liability.
 Sämtliche Angaben erfolgen ohne Gewähr.
 Ces renseignements sont sans garantie.
 Le indicazioni contenute si intendono salvo errori ed omissioni.